

KITCHEN SINK

KS1080SS12SS



Description

- 304 Stainless Steel
- 16 Gauge
- Zero Radius corners
- Sound deadening pads on sides and bottom of Sink
- Overall: 10" x 16" x 8"
- Inside: 8" x 14" x 8"

Codes/Standards Applicable

Specified model meets or exceeds the following:

- ASME A112.19.3

Colors/Finishes

- Stainless Steel

KITCHEN SINK
KS1080SS12SS

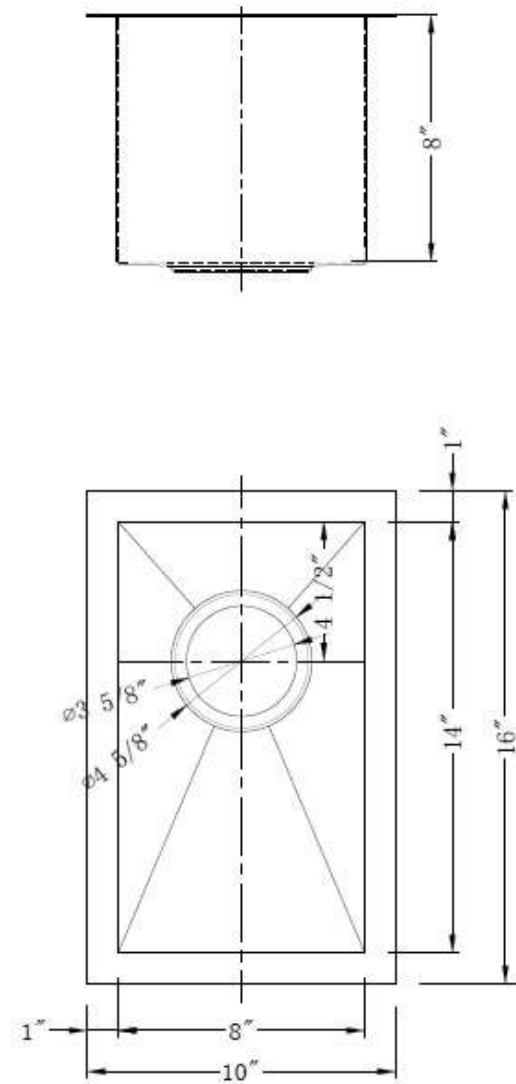

Product Diagram